

# Aircraft Noise Monitoring System

Ever since introducing the sound level meter N-1101 in 1956, RION Corporation has been active as a leader in the field of noise measurement research and in the development and marketing of high-quality sound level measuring equipment.



For over 40 years, we also have been engaged in developing, manufacturing and marketing products designed for environmental noise monitoring.

Ensuring a safe and comfortable living environment for all members of society is more important than ever. We are now offering a state-of-the-art aircraft noise monitoring system that fully reflects our extensive experience and technological know-how in this field.



## The RION advantage

- By manufacturing and configuring all parts of the system in-house — from microphones to sound level meter equipment and aircraft noise processing software — we ensure consistent and accurate operation.
- Support for long-term, unattended monitoring periods is built into the system as a matter of course. The MS-11A microphone incorporates an automatic sensitivity checking function that checks daily for continued accuracy.
- Aircraft noise identification by sound is possible with two integrated methods: sound arrival direction identification and noise event clustering identification using frequency analysis.
- Highly efficient energy saving design, compact dimensions, and low weight.

# All required functions for aircraft noise measurement combined in a single system



Improved aircraft identification supports long-term measurement and generates more accurate data. Compact and lightweight design facilitates installation. Power consumption reduced by about fifty percent.



\*Compared to predecessor NA-37

## Aircraft Noise Monitoring System

This system is designed for automated monitoring of aircraft noise. It is capable of calculating evaluation values according to the "Environmental Standard Related to Aircraft Noise". The sound source identification provided as a standard feature is based on real time 1/3 octave band analysis. A GPS function is also standard, for obtaining location information and enabling automatic time calibration. Collected data can be processed with aircraft noise management software for data compilation, viewing, and creating reports.



- Various noise level data along with time and location information from the GPS are saved on SD card.
- Noise arrival direction information and aircraft transponder data are recorded simultaneously with noise event data. (Using optional Noise Arrival Direction Identification Unit AN-39D and SSR Receiver Unit AN-39R)
- Recording capability for real sound data that can be played back with Aircraft Noise Data Processing Software AS-51 (Using optional Real Sound Recording Software NX-39WR)
- LAN port and modem connector enable Internet connection via an external router or an ordinary telephone line. Data collection and compilation can be performed automatically, and display of map data in real time is also possible. (Using Aircraft Noise Data Processing Software AS-51))
- Standard compliance
  - Environmental Standard Related to Aircraft Noise (Dec. 17, 2007)
  - Aircraft Noise Measurement/Evaluation Manual (Mar. 2020)
  - ISO 20906 : 2009 (Acoustics -- Unattended monitoring of aircraft sound in the vicinity of airports)

# Configuration Example for Aircraft Noise Monitoring System

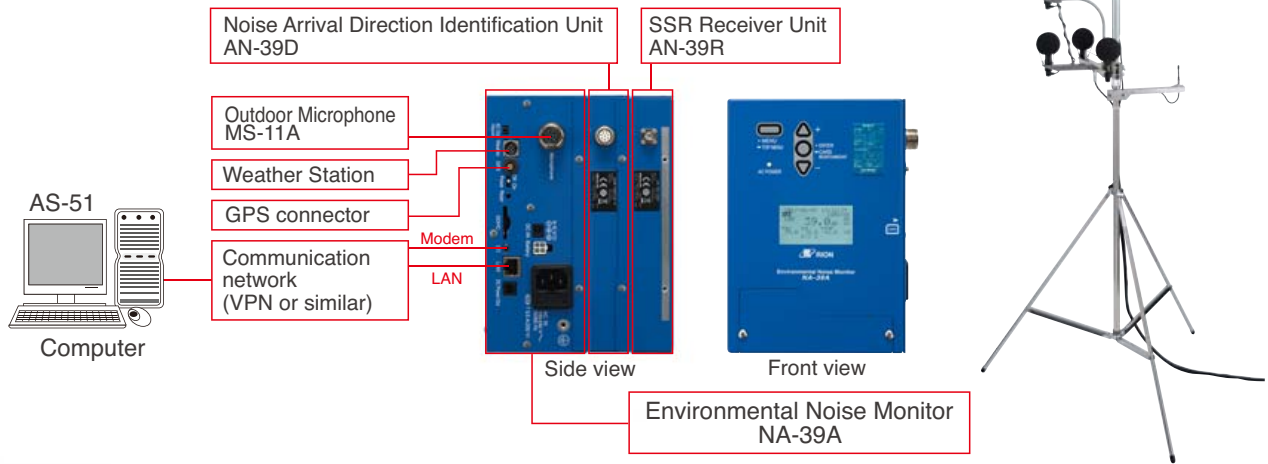

## Product Information

### Environmental Noise Monitor NA-39A

Compliant with IEC 61672-1: 2013 class 1 (JIS C 1509-1: 2017 class 1) (Also when dedicated microphone extension cable up to 105 m and all-weather windscreen is used) Standard configuration includes one-third octave frequency analysis function.

### Noise Arrival Direction Identification Unit AN-39D

Elevation angle and bearing are measured using four microphones, to identify the arrival direction of aircraft noise and ground-level sound. From the sound source location and movement direction, aircraft noise can be identified with high accuracy.

### SSR Receiver Unit AN-39R

Receives SSR (Secondary Surveillance Radar) information used for air traffic control. Capable of capturing the squawk code (temporary 4-digit identification code), pressure altitude, and address (unique aircraft number). (Only for aircraft transmitting this information)

### Outdoor Microphone MS-11A

A microphone is a very delicate and precise device which means that there is a possibility of temporary or permanent change in sensitivity during prolonged outdoor use. The Outdoor Microphone MS-11A therefore incorporates an anti-condensation heater that counteracts the main cause of sensitivity drift. An internal sound source for testing is also provided, enabling daily automatic sensitivity checking.



MS-11A

### All-Weather Windscreen WS-13

The all-weather windscreen is specially designed for the Outdoor Microphone MS-11A used with the Environmental Noise Monitor NA-39A. The combination of NA-39A and WS-13 ensures that the JIS C 1509-1: 2017 class 1 specifications are met with the windscreen in place. Wind noise at a wind speed of 10 m/s is less than 60 dB (A-weighted), and the bird spikes guard against damage by birds. Furthermore, the WS-13 not only reduces the adverse effects of wind noise, it also provides precipitation protection with an IPX3 rating.



WS-13

### Wind noise reduction effect of WS-13

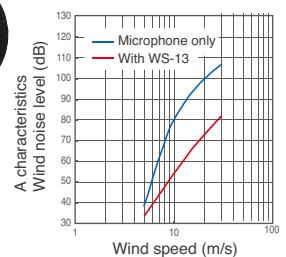

## Options

### Carrying Case

Convenient for mobile measurement.



System example

### Microphone stand for permanent installation ST-88S

This collapsible tripod is easy to set up and maintenance-friendly.



Overall height (fully extended): 4 m

\* The photo shows the product in combination with the WS-13 and AN-39D.

### Cubicle example QC-01

Suitable for outdoor installation. Internal ventilation is a standard feature, and a heater can also be installed as necessary.



System example

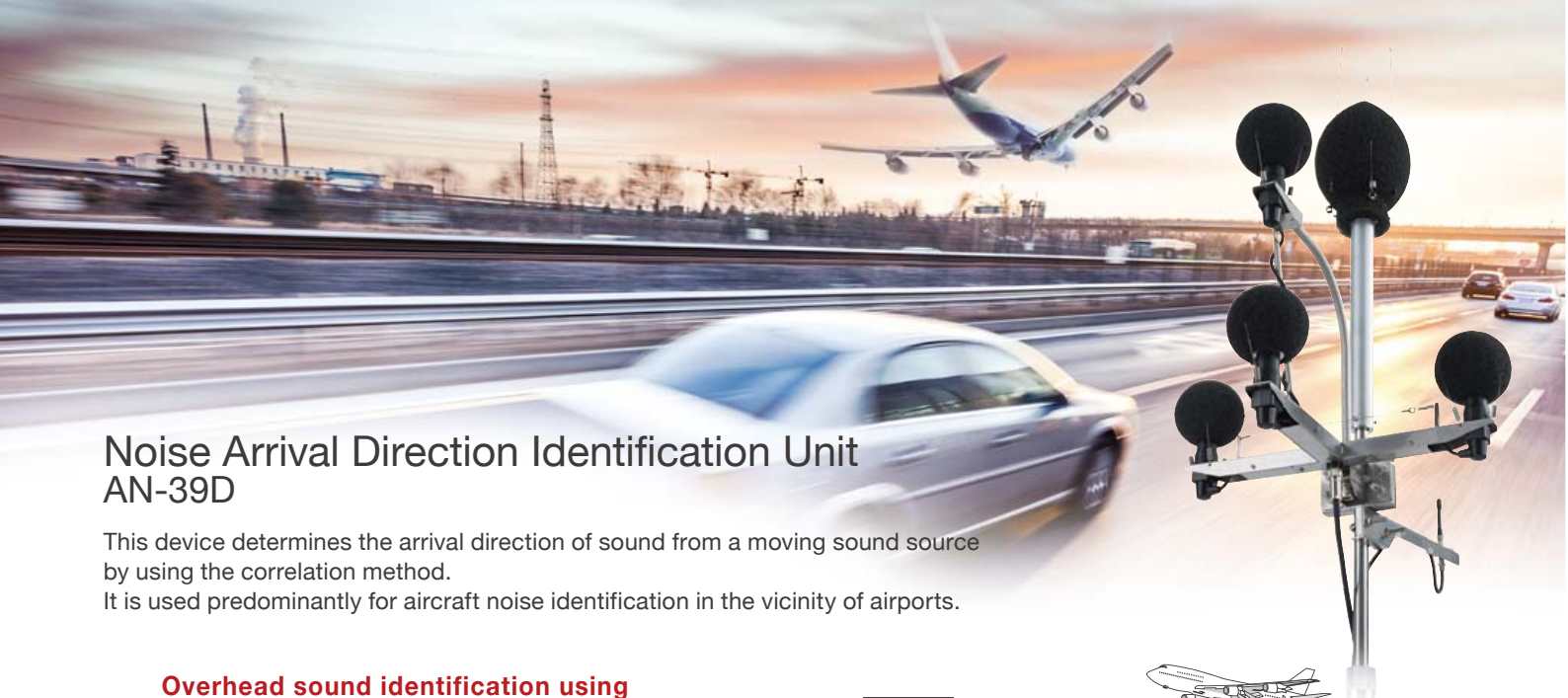

# Noise Arrival Direction Identification Unit AN-39D

This device determines the arrival direction of sound from a moving sound source by using the correlation method. It is used predominantly for aircraft noise identification in the vicinity of airports.



## Overhead sound identification using the correlation method

### Principle

Two microphones are arranged in a perpendicular position as shown in Figure 1, with the distance between the microphones expressed as  $d$ . When the sound from an aircraft arrives with an elevation angle  $\theta$ , the following equation applies, where  $\tau$  is the time difference between the arrival time of the sound at the two microphones (M1, M2), and  $c$  is the acoustic speed in air. Based on the equation, the elevation angle  $\theta$  can be determined.

$$\tau = \frac{d}{c} \times \sin(\theta)$$

When the sound arrival direction is sufficiently steep ( $\theta > 0$ ), the elevation angle information can be used for the identification of aircraft sound. When a sound event is detected, track of elevation angle is also recorded, and events which fulfill certain specified conditions (angle threshold and angle ratio) are considered as aircraft noises.

### Detection of sound arrival direction in 3-axis.

As shown in Figure 2, four microphones are arranged on three orthogonal axes. This allows calculation of sound arrival direction vectors (elevation angle, azimuth angle) which can be used to identify the direction of the sound source more precisely.

Figure 1

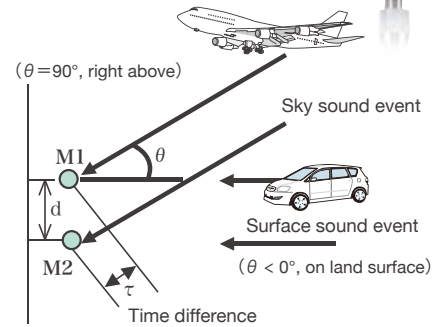
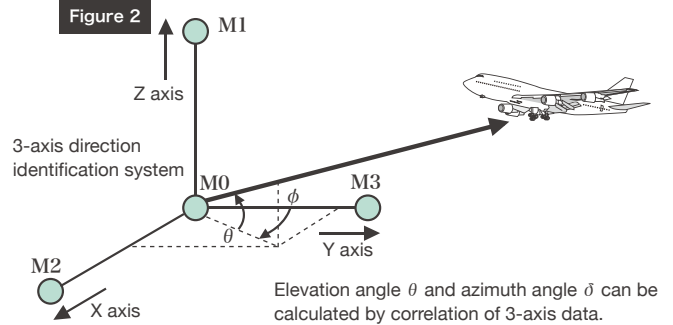

Figure 2



# SSR Receiver Unit AN-39R

This device receives the response signal of the aircraft to the secondary radar (SSR: Secondary Surveillance Radar) of the air traffic control system to detect the proximity of aircraft.

## Identification of aircraft sound using Radar signal method (AN-39R only)

Air traffic control systems constantly send radar inquiry signals to aircraft to which aircraft reply with an identification code and other information including pressure altitude data. The AN-39R can receive such response signals. The distance of approach of an aircraft is detected by receiving the intensity of a radar signal level. By comparing the signal to a certain threshold as synchronized to a sound event, identification of the sound event as aircraft is possible. By using a combination of acoustic and radar signal detection, information of the identification can be increased, especially in acoustically complex locations where the aircraft may be intermittently blocked from other sound.

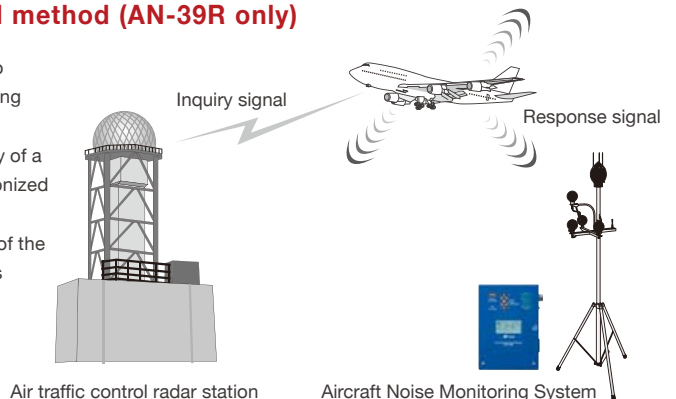

# Example for overhead sound identification

Processes the sound arrival direction data using window function calculation to determine flight noise events, ground-level sound events and other sound events (for exclusion).

**Patent registration numbers for window area identification function**  
 5016724 Environmental noise monitoring device and noise monitoring method  
 5016726 Environmental noise monitoring device and noise monitoring method

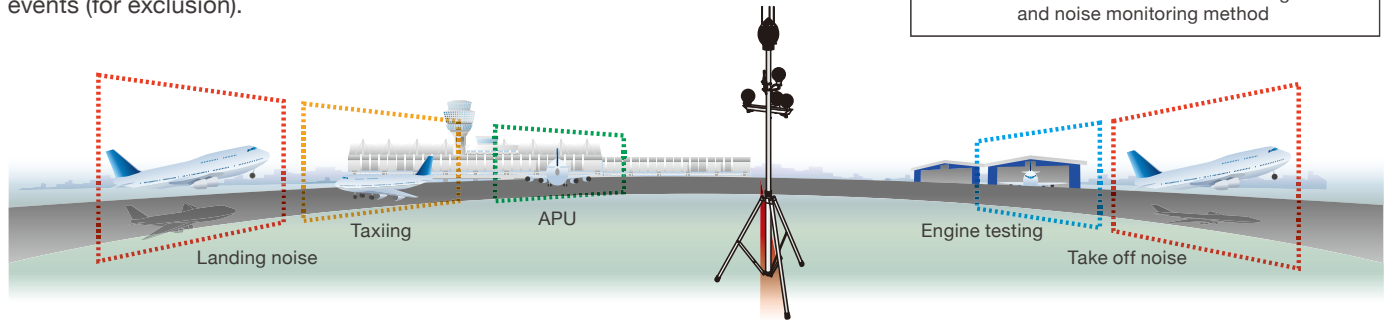

## Aircraft noise event detection method

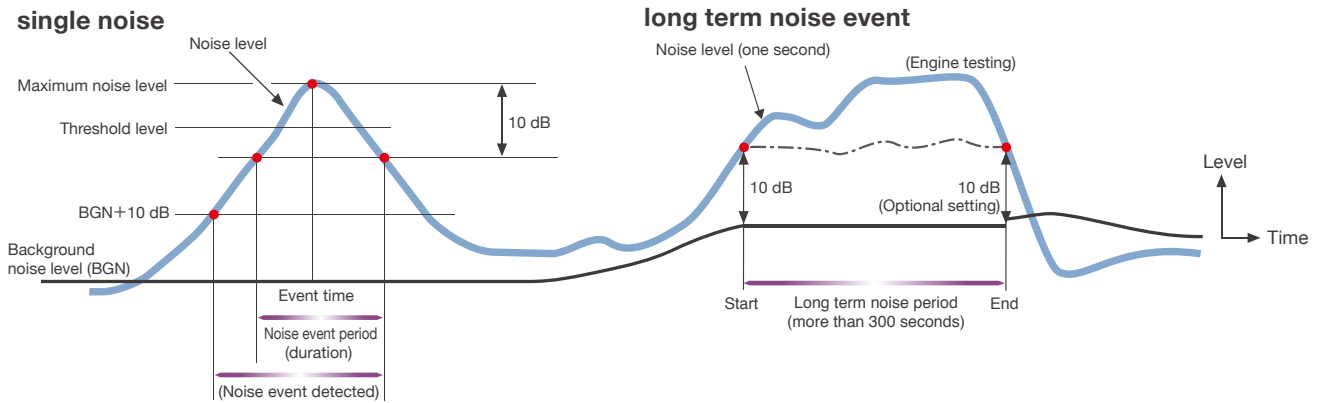

## Visualization of how ground noise is generated

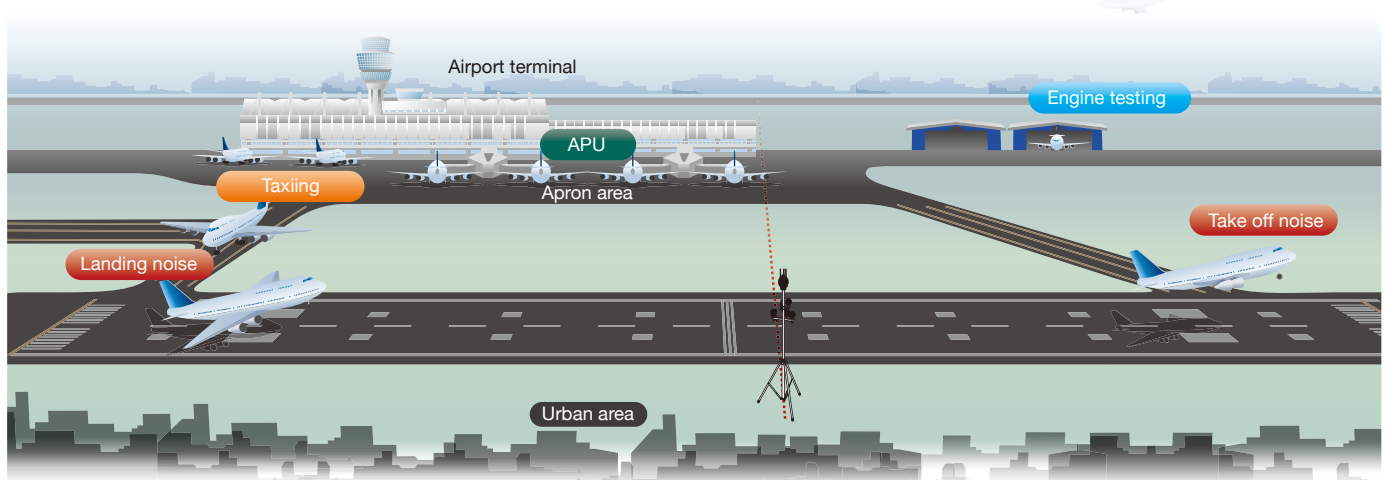

## Description of ground noise

### Types of noise generated by aircraft

#### Single noise event

This is a temporary noise which occurs sporadically, such as noise caused by air travel that can be observed within the vicinity of the airport. Above-ground noise produced by aircraft is also a form of single noise.

#### Long term noise event

This noise is steadily produced over a long period of time, but the noise level fluctuates greatly. Common examples are engine testing noise and the noise originating from the auxiliary power unit (APU).

### Glossary

#### ● Take off noise

This noise occurs from the time the aircraft starts to taxi out from the end of the runway to the time it reaches the middle of the runway and finally takes off.

#### ● Taxiing

Taxiing indicates the ground run of the aircraft as it travels between the tarmac and the runway.

#### ● Landing noise

This noise occurs as the aircraft descends, touches down on the runway of the airport, and then reverses the thrust direction of the engines to reduce speed as it leaves the runway.

#### ● Engine testing

This test is performed to check the operation of the aircraft engines.

#### ● APU

This small engine (Auxiliary Power Unit) is mounted separately from the main aircraft engine. It is the power source used to supply compressed air, hydraulic pressure, and electric power to the aircraft while it is on the tarmac.

#### ● Touch and go

This refers to increasing engine output and taking off from the ground after approaching, landing, and reducing speed on the runway as a part of an exercise for take-off and landing training.

#### ● Hovering

This refers to when a helicopter lifts off and remains stationary while in the air.

# Aircraft Noise Monitoring Software AS-51

The AS-51 software serves for collecting, calculation, viewing, and report creation from data provided by the Aircraft Noise Monitoring System. Measurement data can be acquired via LAN or a modem connection, as well as via SDHC card. Acquired data are automatically calculation and can be output in the form of printed reports or as files.

## Features

- **Real time map display function**  
Allows specifying a map for displaying the location and time variation of noise events.
- **Error detection and alert function**  
Communication problems, microphone cable breaks and other conditions causing an extreme level drop can be detected, triggering an alarm display or alert mail.
- **Sound source labeling function (Option)**  
Using 1/3 octave band analysis, sound arrival direction data, and SSR data, sound source identification can be performed automatically.
- **Web viewing function**  
Daily, monthly and annual reports can be viewed in a web browser connected to the Internet.

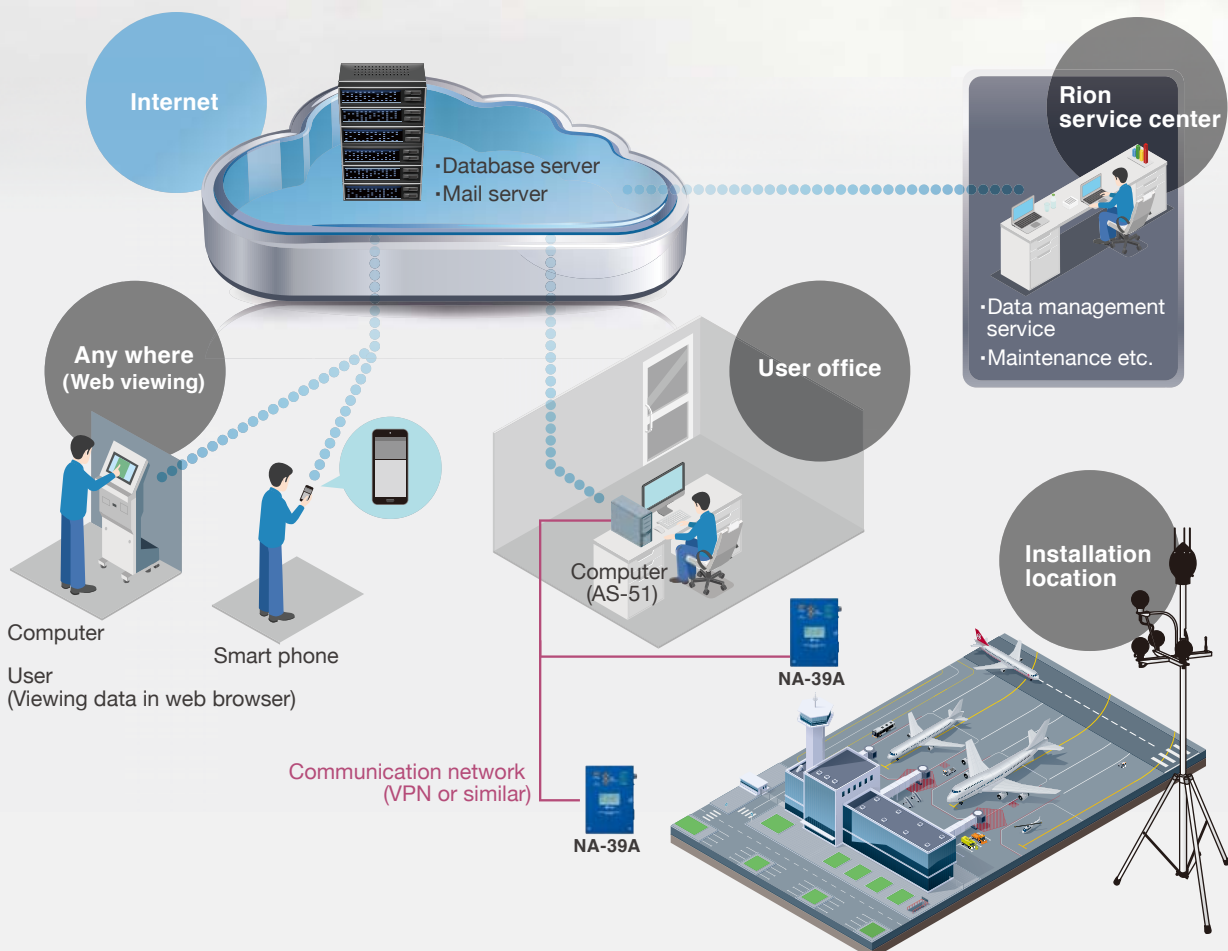

# Real time map viewer

Via web server

The display shows the current position of measurement stations as well as instantaneous measured values and other data in real time.

Realtime map

Sound level time history

History of sound events

Sound event list

# Reports

Daily, monthly and annual reports can be created easily.

- According to customer requirements, Rion can customize report layout.
- Report format can be selected: PDF and/or Excel file.

## Annual Event Summary

Meas. Year : 2016  
 Group Name : Demo  
 Station Name : Station  
 Station Number : 1

Month	L <sub>dn</sub> [dB]	Number of Events			Daytime					NightTime						
		Total	TO	LD	L <sub>d</sub> [dB]	Number of Events	Avg. L <sub>AE</sub> [dB]	Max. L <sub>AE</sub> [dB]	Ave. L <sub>A,30ms</sub> [dB]	Max. L <sub>A,30ms</sub> [dB]	L <sub>n</sub> [dB]	Number of Events	Avg. L <sub>AE</sub> [dB]	Max. L <sub>AE</sub> [dB]	Ave. L <sub>A,30ms</sub> [dB]	Max. L <sub>A,30ms</sub> [dB]
2016/04	71.5	1,239	661	578	73.5	1,236	104.7	115.6	96.0	107.1	26.7	3	55.7	86.1	47.8	76.5
2016/05	71.6	1,332	771	561	73.6	1,330	104.6	114.5	96.1	106.3	16.1	2	47.8	73.7	42.1	70.5
2016/06	71.0	1,468	645	823	72.9	1,460	103.4	113.8	94.8	107.7	46.3	8	74.5	105.9	75.2	106.8
2016/07	71.1	1,624	897	726	73.1	1,624	103.3	114.1	94.8	108.7	...	0	...	...	...	...
2016/08	69.3	1,111	512	599	71.3	1,111	103.1	113.3	94.9	107.9	...	0	...	...	...	...
2016/09	71.2	1,313	795	518	73.3	1,312	104.2	113.3	95.7	105.6	24.2	1	52.9	84.1	44.2	75.4
2016/10	70.6	1,619	772	846	72.6	1,617	102.8	113.4	94.3	105.7	19.9	2	47.8	77.5	43.2	73.0
2016/11	70.6	1,818	685	1,133	72.6	1,817	102.1	113.5	93.8	106.3	17.5	1	44.8	77.4	39.5	72.1
2016/12	66.5	1,815	316	1,499	68.6	1,812	98.2	116.2	90.3	110.5	29.3	3	56.7	85.1	45.8	75.8
2017/01	67.2	1,712	322	1,390	69.2	1,709	99.1	113.7	91.0	109.3	22.4	3	50.1	78.1	43.6	72.1
2017/02	68.5	1,669	454	1,215	70.5	1,669	100.1	112.4	91.7	104.6	...	0	...	...	...	...
2017/03	66.7	1,415	290	1,125	68.7	1,415	99.4	113.8	91.1	105.7	...	0	...	...	...	...

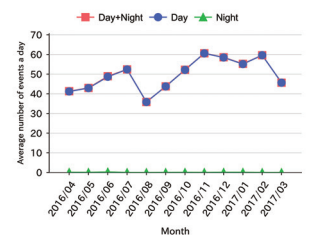
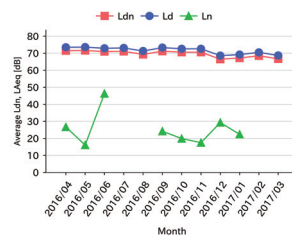

Calculated at : 2018/11/21 10:53:23  
 Printed at : 2018/11/30 09:13:37

AS-51 Web Version 1.6.1.0

## Windows application



## Data edit screen

Data edit screen gives access to noise event data, for editing and viewing of different aspects.

Real-sound playback

Sound arrival direction

Frequency analysis (1/3 octave band)

Aircraft information (SSR reception data)

The sound event classification is done automatically (Items without\* symbol are aircraft noise events). Furthermore, playing back audio file is useful to confirm each event by users (NX-39WR is required).

SSR reception data display

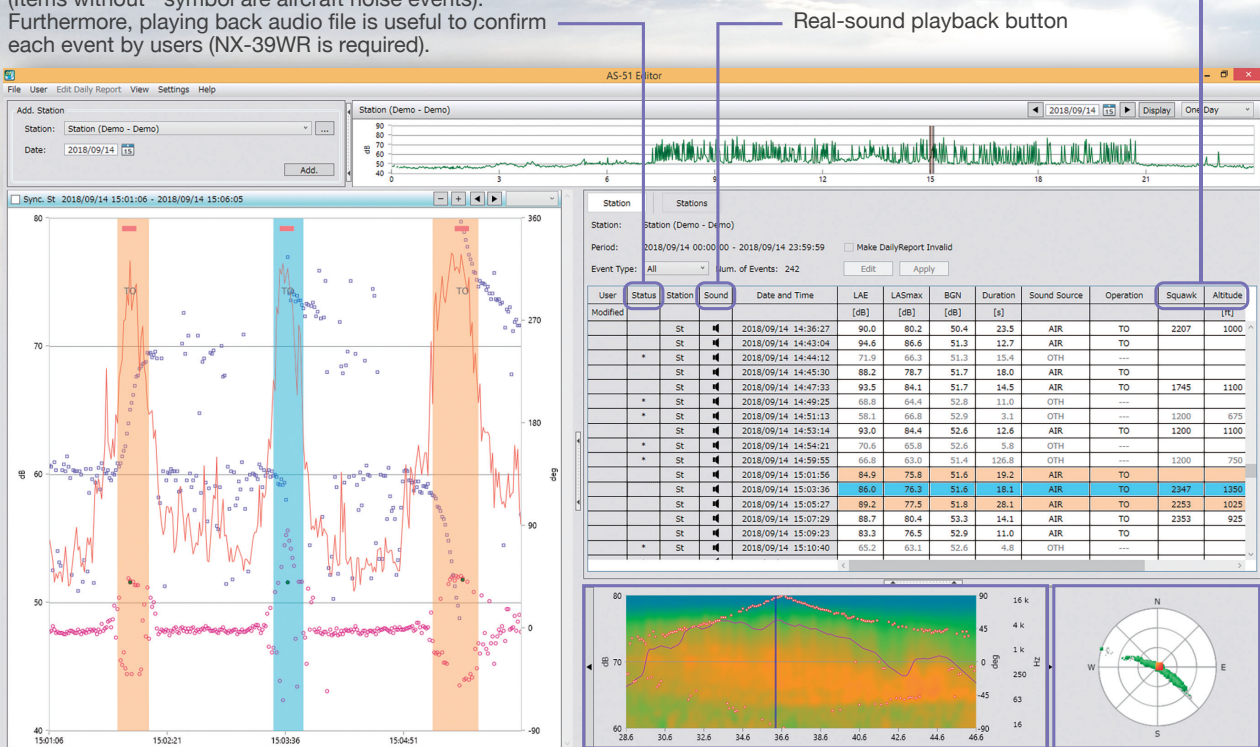

Data edit screen

1/3 octave band analysis results

Sound arrival direction

## Sound source labeling function (Option)

The age of sound source identification has arrived.

The sound source labeling function comprehensively evaluates various types of information such as frequency, sound arrival direction, SSR data etc. to identify the sound source.

Compared to earlier methods that only relied on arrival direction and SSR, even sound events that were difficult to pin-point can now be classified more reliably.

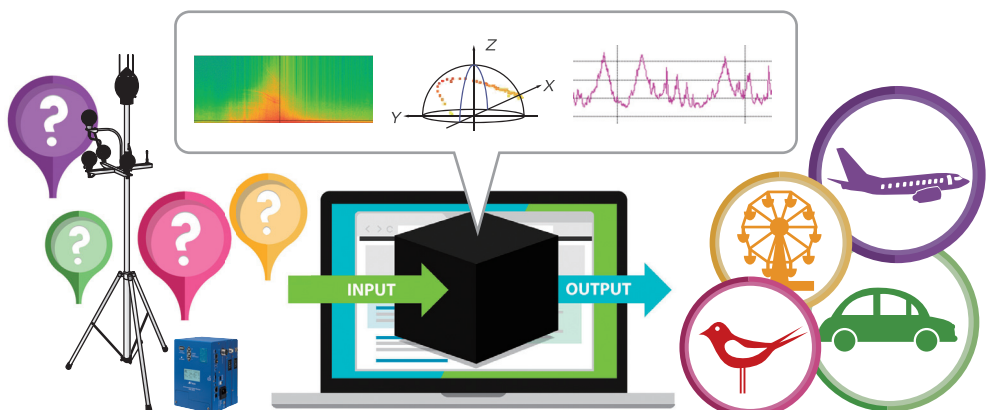



# Related system

## Aircraft Flight Tracking System SKYGAZER™

Measure flight paths in real time with this small suitcase sized system.

- Allows observation of aircraft flight paths by simple reception of radio signals
- Powerful analysis capability and coverage for a radius of 200 km or more
- Compact high-performance SSR (Secondary Surveillance Radar)reception module ensures stable operation
- Simple all-in-one system configuration
- Easy setup
- Skygazer monitors flight track using Mode A/C transponder with PSSR ( Passive Secondary Surveillance Radar )and ADSB.



Short-time measurement



Permanent measurement

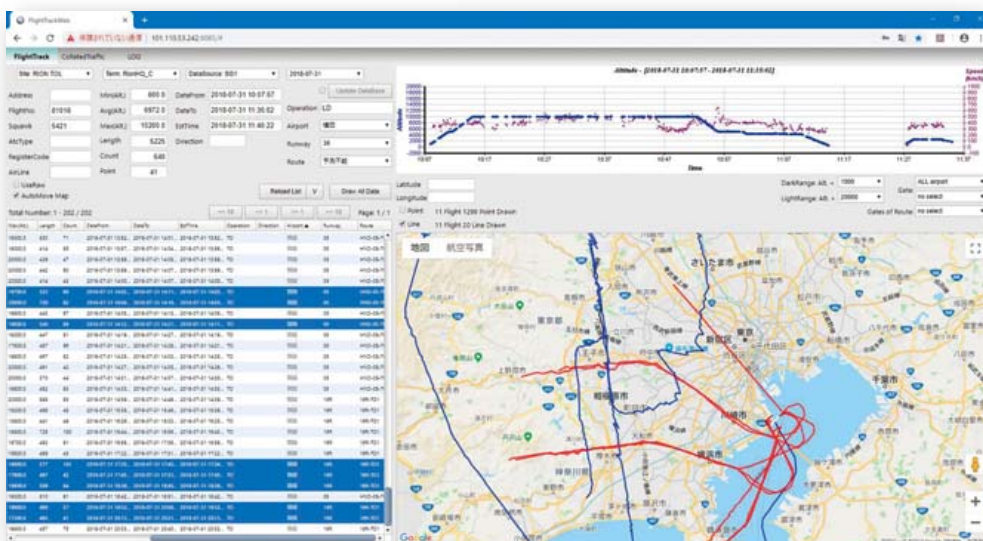

PSSR  
(Passive Secondary Surveillance Radar)

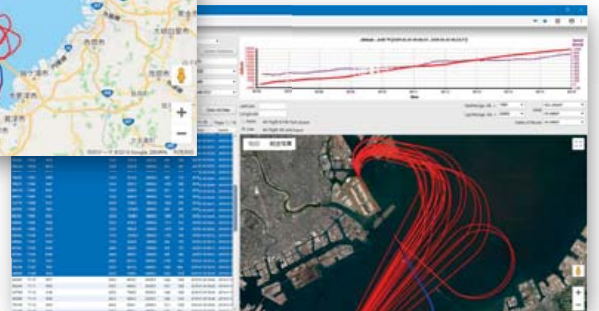

ADS-B

## ■ Specifications NA-39A

Applicable standards	Measurement Act, High-Precision Sound Level Meter, JIS C 1516: 2020 (Sound level meters – Measuring instruments used in transaction or certification) IEC 61672-1: 2013 class 1, JIS C 1509-1: 2017 class 1, IEC 61260: 2014 class 1, EN61326-1, EN300 440-2, CE marking, Low Voltage Directive, WEEE Directive, VCCI class B
Measurement functions	
RAW data (every 100 ms)	Time-weighted sound pressure level $L_p$ Time average sound pressure level $L_{eq}$ Maximum time-weighted sound pressure level $L_{max}$ Minimum time-weighted sound pressure level $L_{min}$ Peak sound pressure level $L_{peak}$ * Any combination of frequency weighting characteristics A/C/Z and time weighting characteristics F/S/I is possible. * Data recorded on recording media and data output via communication link can be any two of the above functions.
LCD data display	Time-weighted sound pressure level $L_p$ Time average sound pressure level $L_{eq}$ Maximum time-weighted sound pressure level $L_{max}$ Peak sound pressure level $L_{peak}$ * Any combination of frequency weighting characteristics A/C/Z and time weighting characteristics F/S/I is possible. * Screen display is possible for one of the above functions.
1/3 octave band data (every 100 ms)	Time-weighted sound pressure level $L_p$ Time average sound pressure level $L_{eq}$
Real sound data	Option (NX-39WR)
Measurement data	$L_{eq}$ - 1s, $L_{eq}$ 1 min, environment vector, single noise event, SSR event, single noise event arrival direction, event spectrum
Microphone and preamplifier	Outdoor Microphone MS-11A
Measurement level range	
A-weighted	28 dB to 138 dB
C-weighted	36 dB to 138 dB
Z-weighted	42 dB to 138 dB
Residual noise level	
A-weighted	20 dB max.
C-weighted	28 dB max.
Z-weighted	34 dB max.
Measurement frequency range	10 Hz to 20 kHz
Frequency weighting	A characteristics, C characteristics, Z characteristics
Time weighting characteristics	F (Fast), S (Slow), I (Impulse)
Level range switching	No (single range requires no switching)
RMS detection circuit	Digital processing method
Sampling cycle	$L_p$ , $L_{eq}$ , $L_{max}$ , $L_{min}$ , $L_{peak}$ 20.8 $\mu$ s (Sampling frequency 48 kHz)
Reference frequency	1 kHz
Reference sound pressure level	94 dB
Correction function	
Windscreen correction	Provides frequency response correction so that standard requirements are met with windscreen WS-13 attached; on/off switchable by key operation or communication command.
Diffuse sound field correction function	Provides frequency response correction so that standard requirements are met in a diffuse sound field On/off switchable by communication command * This product is referenced to zero degrees (front of microphone).
Display and main display contents	Monochrome LCD with backlight, 64 (H) x 128 (W) dots Numeric display: 0.1 dB resolution (refresh cycle 0.5 s) Alarm indication: OVER triggered at 138.3 dB (1 kHz) UNDER triggered at -0.5 dB below measurement lower limit Language: English
Operation panel	
Input/output connectors	
LAN port	1 (10BASE-T/100BASE-TX)
Modem connector	1
Weather meter connector	For meteorograph data acquire and control
AC output	
Frequency weighting	A characteristics / C characteristics / Z characteristics (selectable by key operation or remote command)
Output voltage	1 Vrms (at full-scale point), full-scale 90 dB / 110 dB / 130 dB (selectable by key operation or remote command)
Output impedance	50 $\Omega$
Load impedance	10 k $\Omega$ or more
Recording media	SDHC card (standard 8 dB) Internal memory (4 GB, for backup use)
Data storage	Raw data, measurement data, and messages are saved in a specified format on the recording media.

Event detection function	Single noise events and long-term noise events can be detected in accordance with aircraft noise measurement manuals.
Clock	
Functionality	Year / Month / Day / Hour / Minutes / Seconds (0.1 s resolution)
Accuracy	$\pm$ 10 ppm or better
Calibration	Clock calibration by GPS or NTP
Power requirements	
AC power source	
Input voltage range	100 to 240 V AC ( $\pm$ 10 %)
Power supply frequency	50 Hz/60 Hz ( $\pm$ 5 %)
DC power source (12 V)	
Operation voltage range	9 to 15 V
Power failure backup battery (12 V)	With charging function while AC power is supplied (Option)
Supported battery type	12 V sealed lead-acid storage battery
Ambient conditions for operation	
Temperature	-10 °C to +50 °C
Humidity	max. 90 % RH (no condensation)
Dimensions and weight	
Dimensions	Approx. 200 (H) x 140 (W) x 79 (D) mm (without protruding parts)
Weight	Approx. 1.5 kg (excl. microphones and cables)
Supplied accessories	Outdoor microphones, power cord, GPS antenna (with 3 m cable), SDHC card (8 GB)

## ● Options

Name	Model
Noise Arrival Direction Identification Unit	AN-39D
SSR Receiver Unit	AN-39R
Real Sound Recording Software	NX-39WR
Aircraft Noise Data Processing Software	AS-51
Enclosure example	QC-01
Enclosure mounting brackets	NA39S110
Carrying case (Special cases for various solutions)	
Weather Sensor (Meteorograph)	
Lead-acid storage battery	
External battery connection cable	
Modem cable	CC-42M
SDHC card (8 GB)	MC-80SS2
All-weather windscreen	WS-13
Microphone stand for permanent installation	ST-88S
7P microphone extension cable	EC-04 series
Identification extension cable	EC-39D series
SSR antenna extension cable	EC-39R series
GPS extension cable	59GPS series

## Outdoor Microphone MS-11A

Microphone	1/2 inch electret microphone
Nominal outer diameter	13.2 mm
Sensitivity level (incl. preamplifier)	-28 dB (re 1 V/Pa at 1 kHz, reference environment)
Built-in sound source	250 Hz, 500 Hz, 1 kHz, 4 kHz (for operation checking) 114 dB (Sound pressure level)
Heater	
Heater current	94 mA DC
Heater power consumption	0.9 W
Ambient conditions for operation	-20 °C to +50 °C, 100 % RH or less (no condensation)
Storage temperature range	-10 °C to +50 °C
Dimensions and weight	Outer diameter: 24 mm x 141.3 mm / approx. 120 g

### Real Sound Recording Software NX-39WR

For real sound recording function	Records the sound pressure level waveform obtained from the sound level meter of the NA-39A as a file.
File format	
Data	Non-compressed (WAV), Lossy compression (mp3)
Bit word length	16/24 bits, selectable
Sampling frequency	48 kHz
Frequency weighting	Z characteristics
Data volume	Aircraft noise, 40 days (1 000 events per day / 5 s duration / mp3): Approx. 55 hrs (4 hrs if non-compressed) * 8 GB SDHC card
Trigger functions	
Event trigger	Recording from Lmax detection when single noise event detection is used Recording begins from immediately before Lmax
LTNE event trigger	Recording a part of event sections at multiple locations when constant noise event detection is used
Interval trigger	Recording starts at constant intervals and continues for a specified duration (Example: Recording 10 minutes in every hour)
Level trigger	Recording is always performed while the noise level exceeds a certain threshold (interval trigger)

### Noise Arrival Direction Identification Unit AN-39D

Main unit	
Measurement range	35 dB to 130 dB (no frequency correction)
Input frequency	20 Hz to 20 000 Hz
A/D converter	Resolution 24 bits
Ambient conditions for operation	-10 °C to +50 °C, 90 % RH or loss
Dimensions and weight	200 (H) x 140 (W) x 32.9 (D) mm main unit / Approx. 520 g
Microphone stay section	
Sensors	Microphone x 4, Preamplifier x 4
Dimensions and weight	421 (H) x 444 (W) x 323 (D) mm / Approx. 2.6 kg

### SSR Receiver Unit AN-39R

Applicable standards	CE marking, WEEE Directive
Input section	
Antenna	1/4λ omnidirectional antenna x 1 (SMA connector)
Input connector	SMA x 1
Measurement range	Within approx. 10 km
Carrier frequency	1 090 MHz
Ambient conditions for operation	-10 °C to +50 °C, 10 % to 90 % RH
Dimensions and weight	200 (H) x 140 (W) x 32.9 (D) mm / Approx. 560 kg (Mounting on 22 mm dia. and 32 mm dia. microphone stands supported)
Supplied accessories	Antenna: 1/4λ antenna x 1 Antenna stay x 1 (incl. bolt)

### Recommended computer specifications for Aircraft Noise Data Processing Software AS-51

CPU	Intel Core i5 2 GHz or faster
RAM	8 GB or more
Display	XGA (1024 x 768 pixels) resolution or higher
OS	Microsoft Windows 7 Professional 64 bit, 8.1 Pro 64 bit, 10 Pro 64 bit

### ● Dimensional Drawing (Unit : mm)

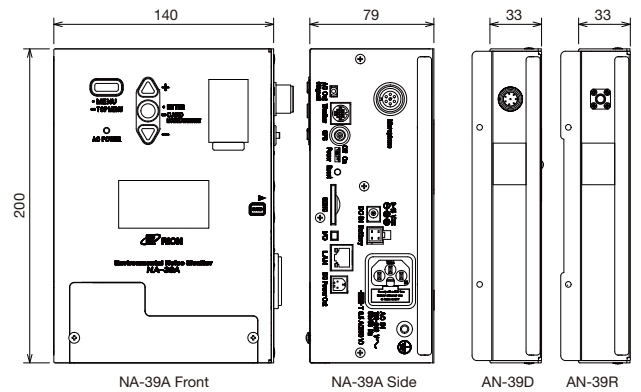

### ● WS-13 Structural Diagram (Unit : mm)

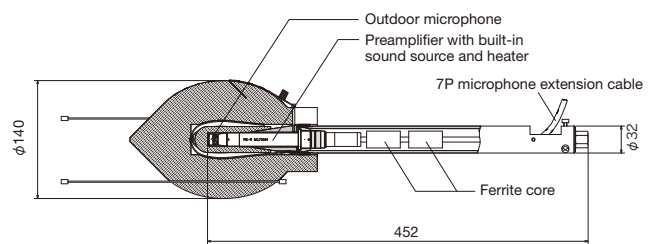

### ● External view of sensor section

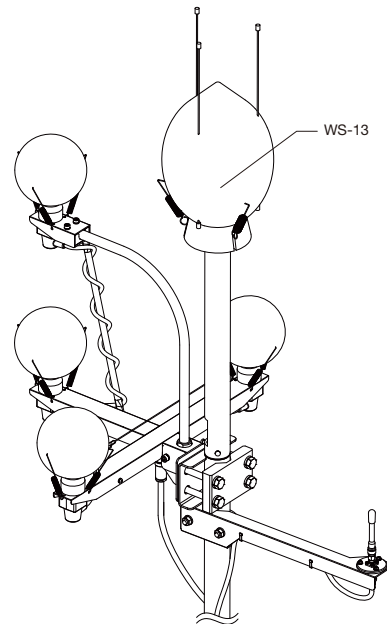

RION CO., LTD. is recognized by the JCSS which uses ISO/IEC 17025 as an accreditation standard and bases its accreditation scheme on ISO/IEC 17011. JCSS is operated by the accreditation body (IA Japan) which is a signatory to the Asia Pacific Accreditation Cooperation (APAC) as well as the International Laboratory Accreditation Cooperation (ILAC). The Quality Assurance Section of RION CO., LTD. is an international MRA compliant JCSS operator with the accreditation number JCSS 0197.



\* Windows is a trademark of Microsoft Corporation. \* Specifications subject to change without notice.

Distributed by:



3-20-41, Higashimotomachi, Kokubunji, Tokyo 185-8533, Japan  
 Tel: +81-42-359-7888 Fax: +81-42-359-7442

